

template block frame

template door panel

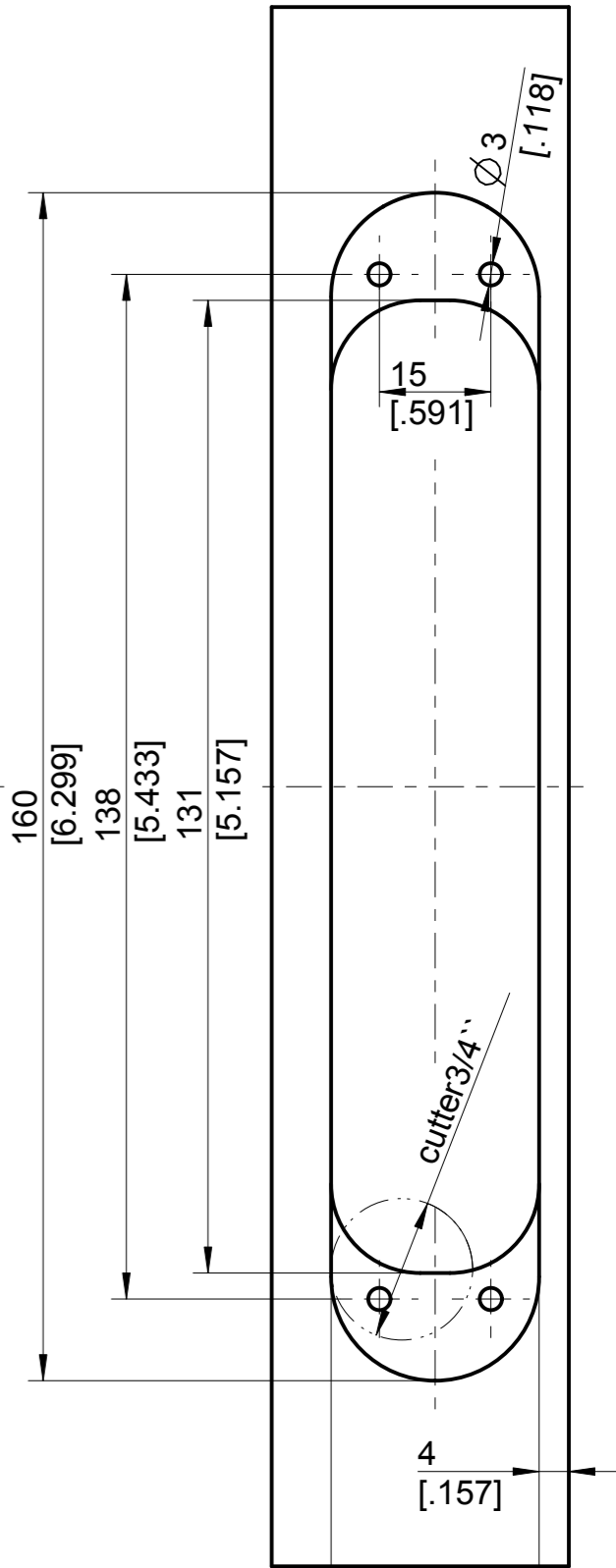
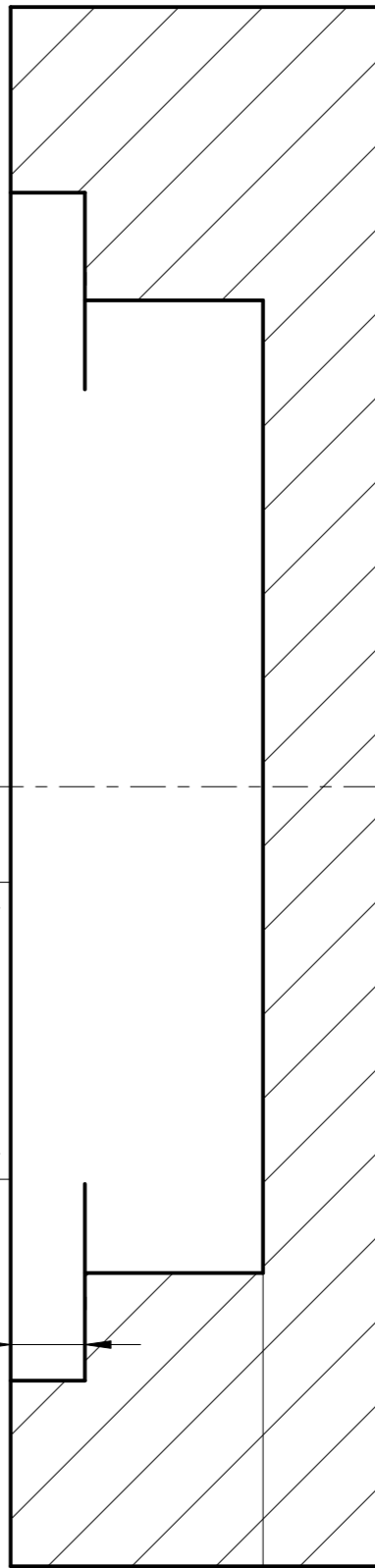

calculation of the routing:

Dimension A  
Dimension B

$A - B + 0.157'' = \text{Dimension X}$

the result must be a Dimension between 0.157'' and max. 0.236''

Kunde:USA				Zul. Abweichung nach DIN:		Werkstoff:		Maßstab:		
- x -	-	-	-	-		-		1:1		
- x -	-	-	-	-		-		-		
- x -	-	-	-	Gew.	-		Benennung, Type:			
- x -	-	-	-	Datum	Name		<b>Fräsbild Blockzarge</b> <b>TECTUS TE340-3D US</b>			
- x -	-	-	-	Gez.	Kirsch.					
- x -	-	-	-	Gep.	Gor.		Dokumenttype: Bohr-/Fräsbild			
- x -	-	-	-	Lebenszyklusphase:			Verkaufs.-Nr.:			
- x -	-	-	-	Serie			-		Proje. M.	Format:
- x -	-	-	-	Ersatz für/durch:			-		☐	A3
- x -	-	-	-	-			-		Blatt:	
- x -	-	-	-	-			-		4	
x	-	-	-	-			-		-	
Zust.	Änderung	Datum	Name	<b>SIMONSWERK</b> BANDTECHNIK		Zeichnungs.-Nr.:		5 400605 0 00000		

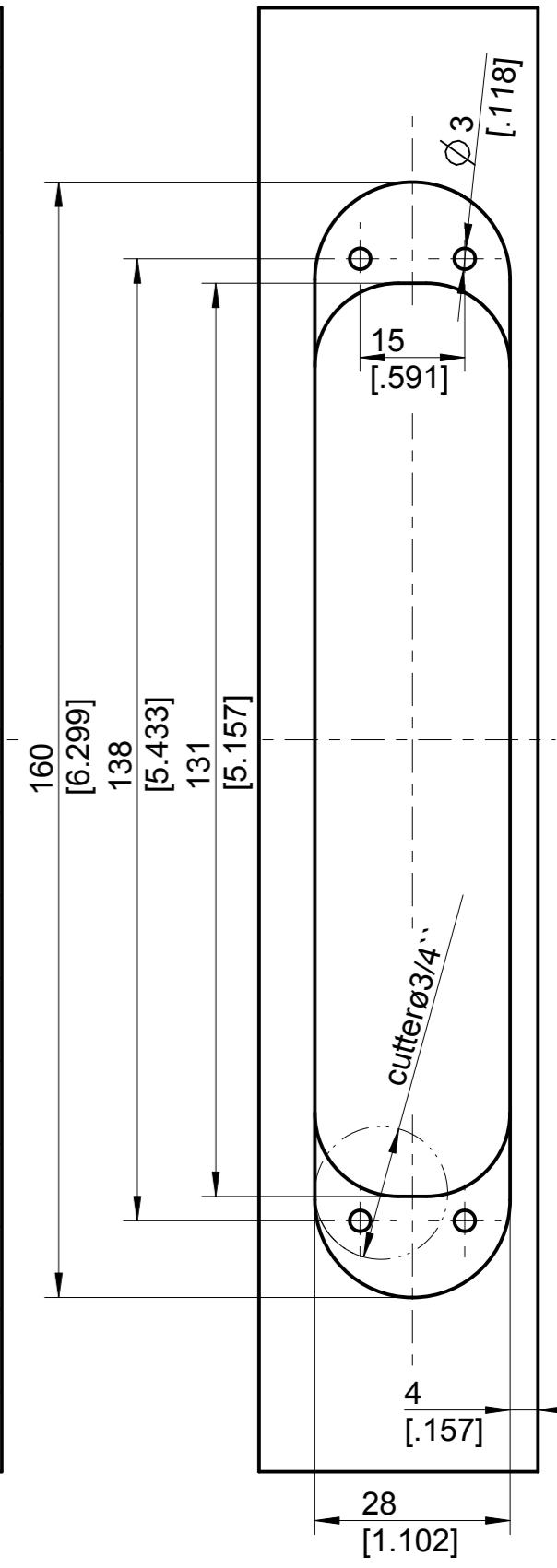
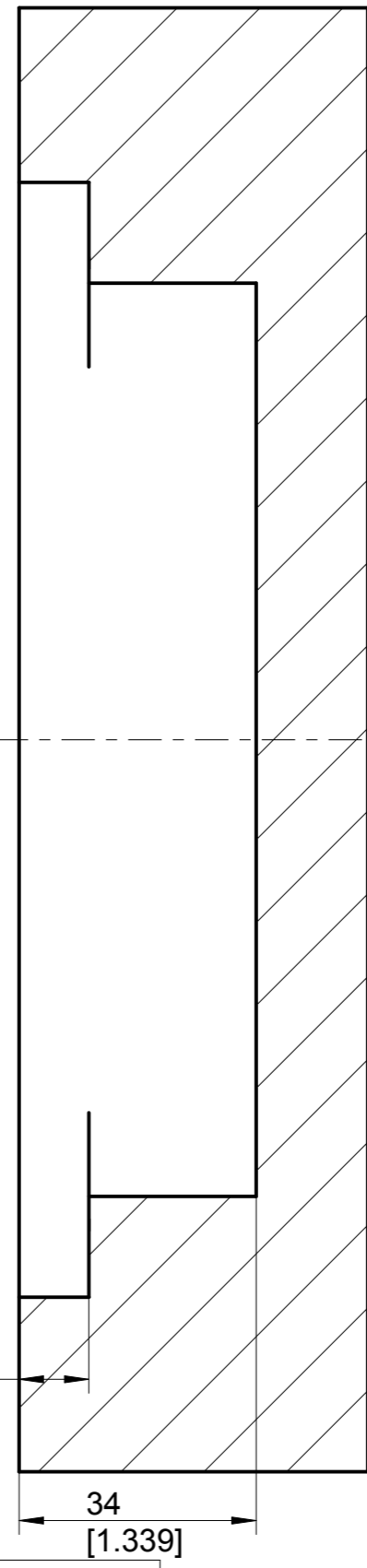
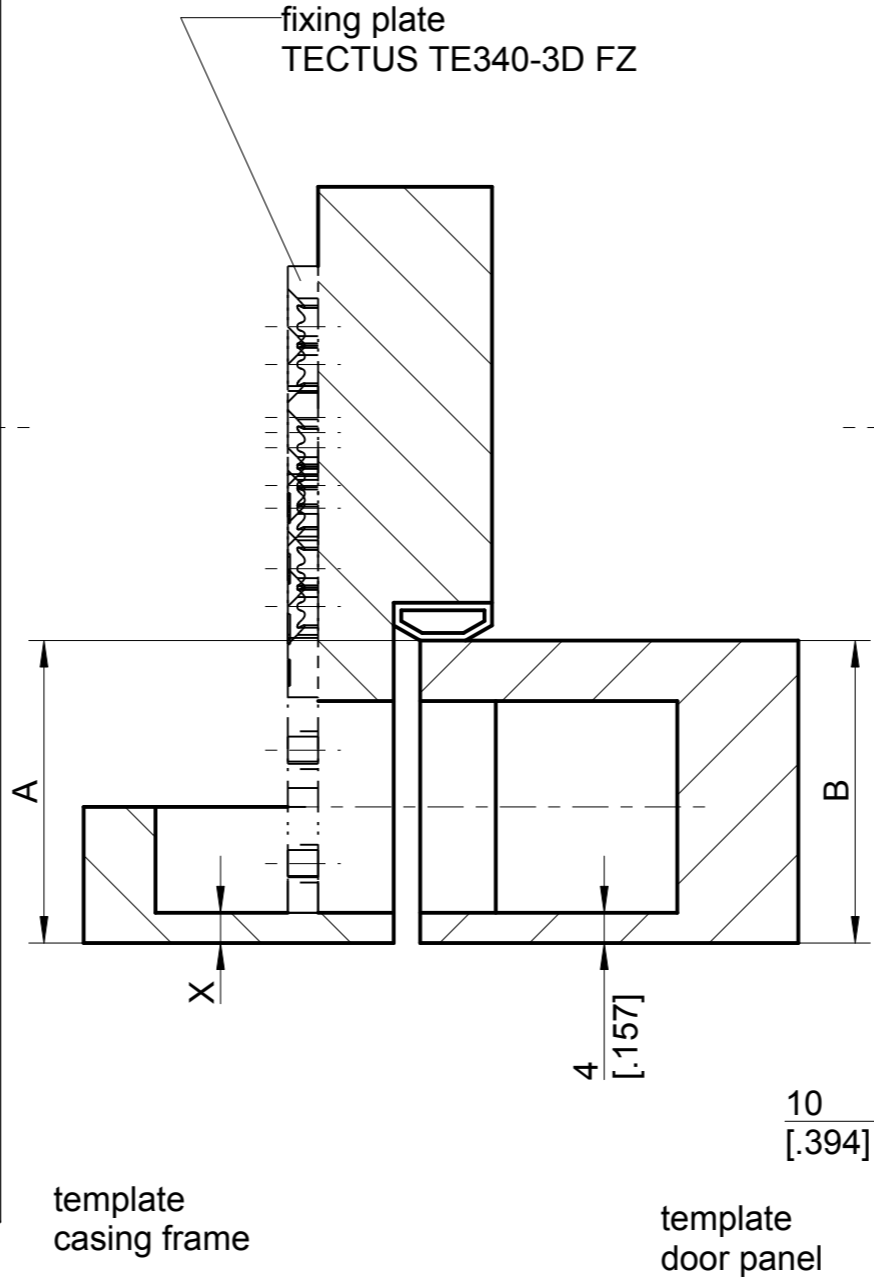
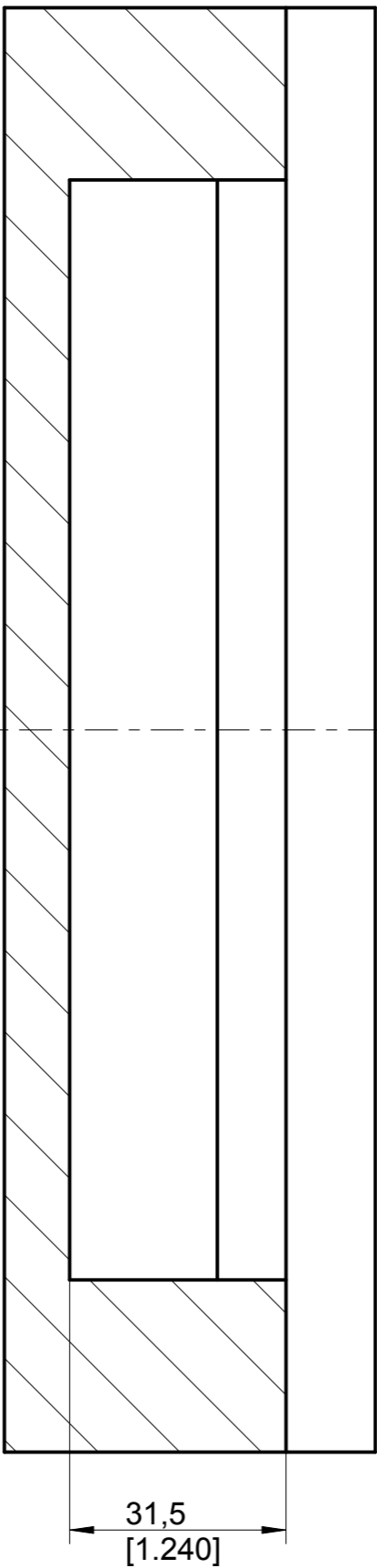
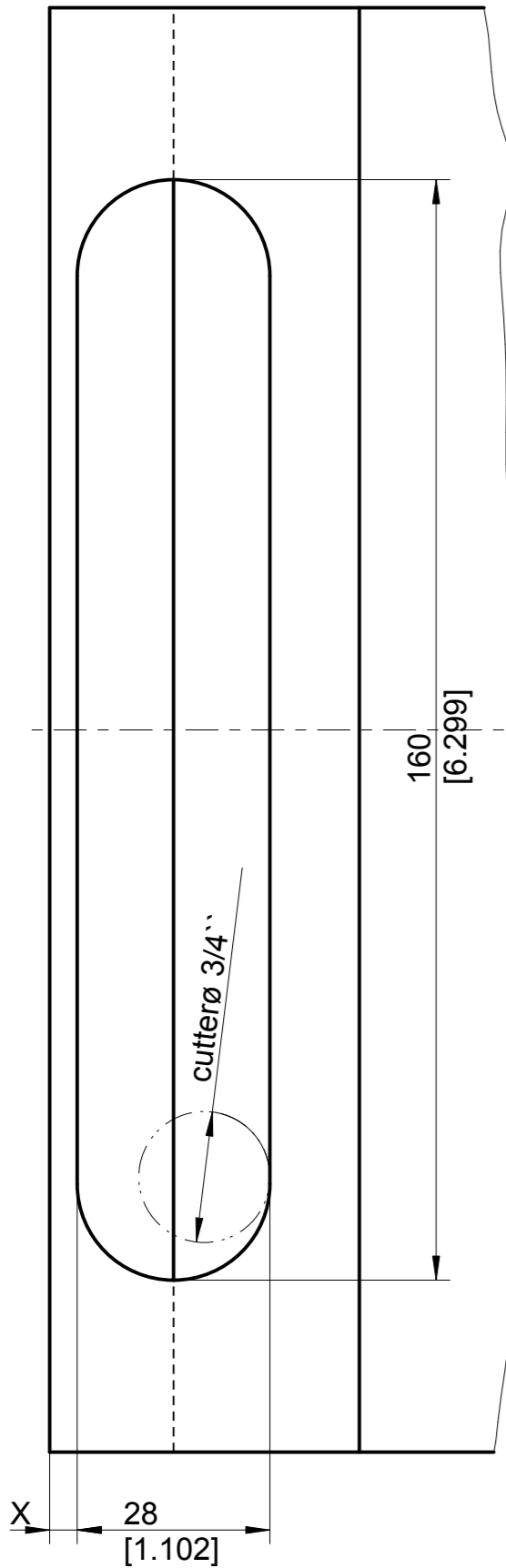

calculation of the routing:

Dimension A  
Dimension B

$A - B + 0.157'' = \text{Dimension X}$

the result must be a Dimension between 0.157'' and max. 0.236''

Kunde:USA				Zul. Abweichung nach DIN:		Werkstoff:		Maßstab:	
- x -	-	-	-	-		-		1:1	
- x -	-	-	-	-		-		-	
- x -	-	-	-	Gew.		Benennung, Type:			
- x -	-	-	-		Datum	Name		Fräsbild Futterzarge	
- x -	-	-	-	Gez.	26.05.20	Kirsch.		TECTUS TE340-3D FZ US	
- x -	-	-	-	Gepr.	17.06.20	Gor.		Dokumenttype: Bohr-/Fräsbild	
- x -	-	-	-	Lebenszyklusphase:				Verkaufs.-Nr.:	
- x -	-	-	-	Serie				-	
- x -	-	-	-	Ersatz für/durch:				Proje. M.	
- x -	-	-	-	-				Format:	
- x -	-	-	-	-				A3	
- x -	-	-	-	-				Zeichnungs.-Nr.:	
x	-	-	-	-				Blatt:	
Zust.				Änderung		Datum		Name	
								SIMONSWERK BANDTECHNIK	
								5 400605 0 00000	
								5	

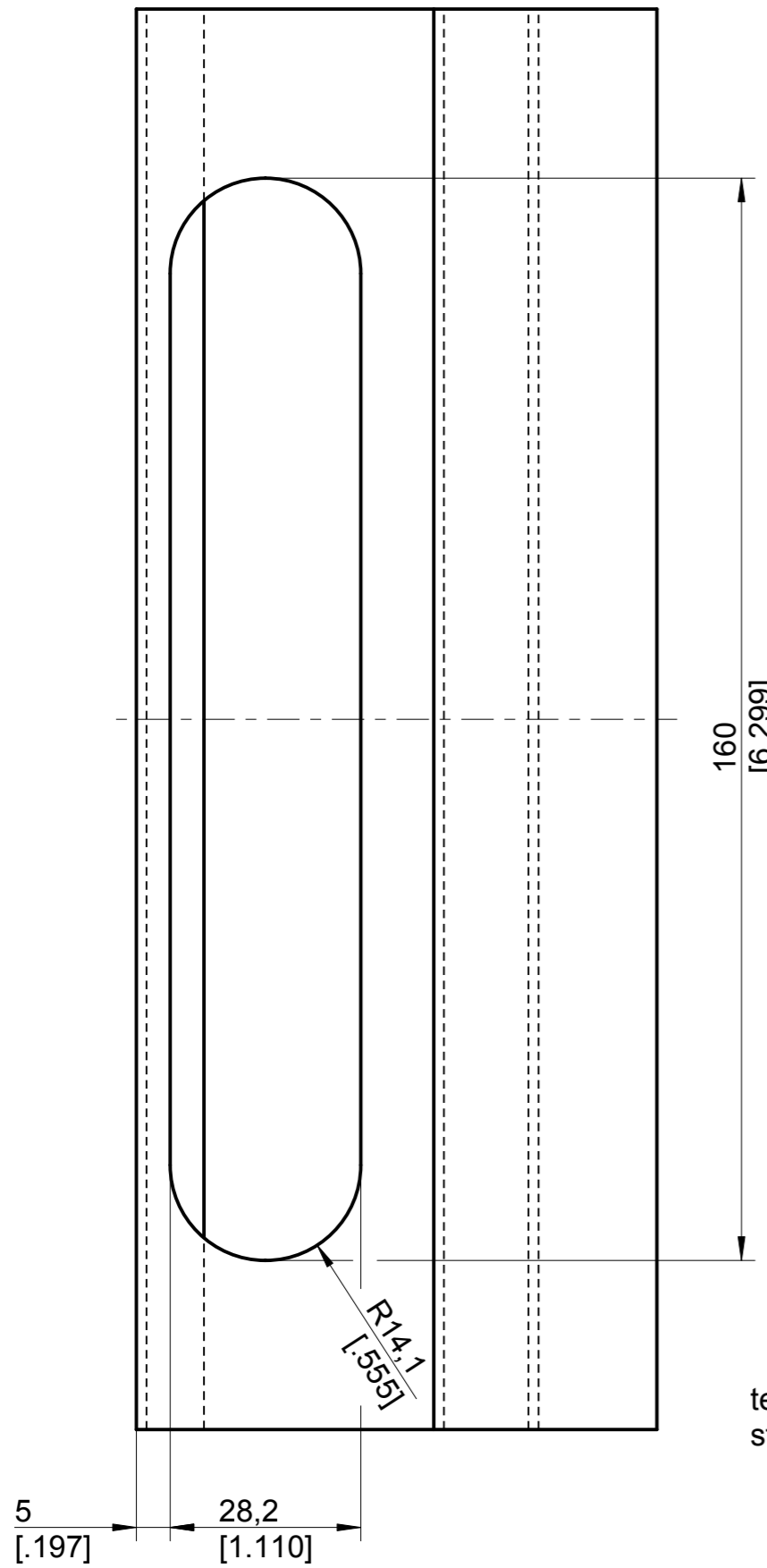

template steel frame

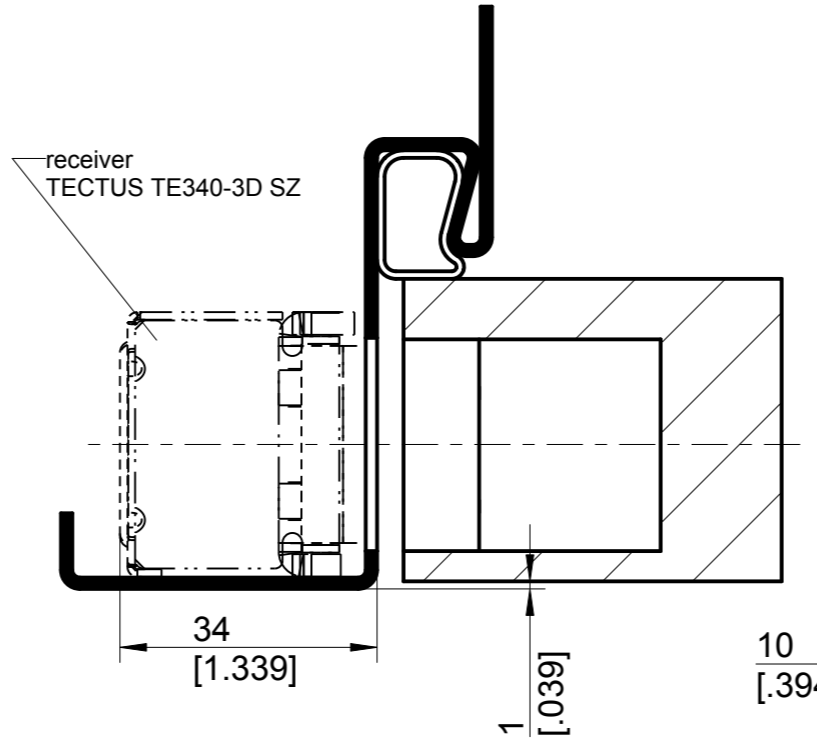

template door panel

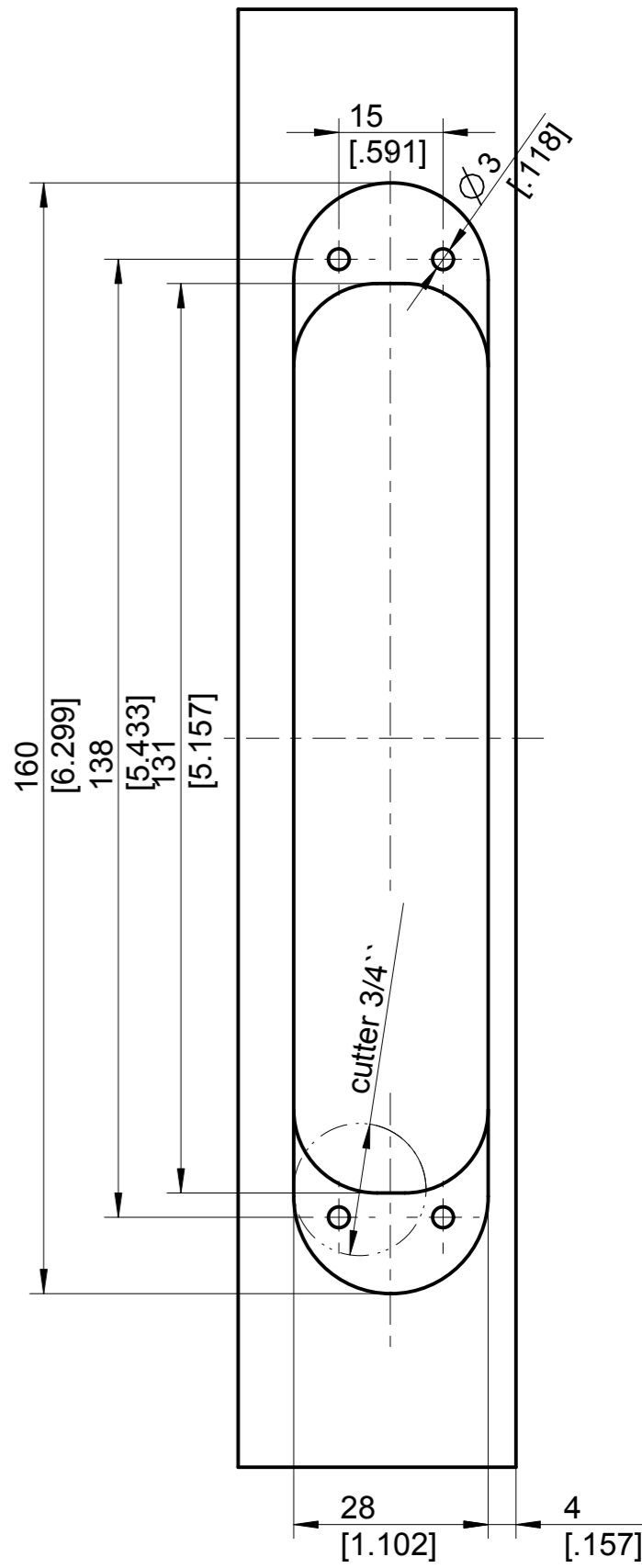
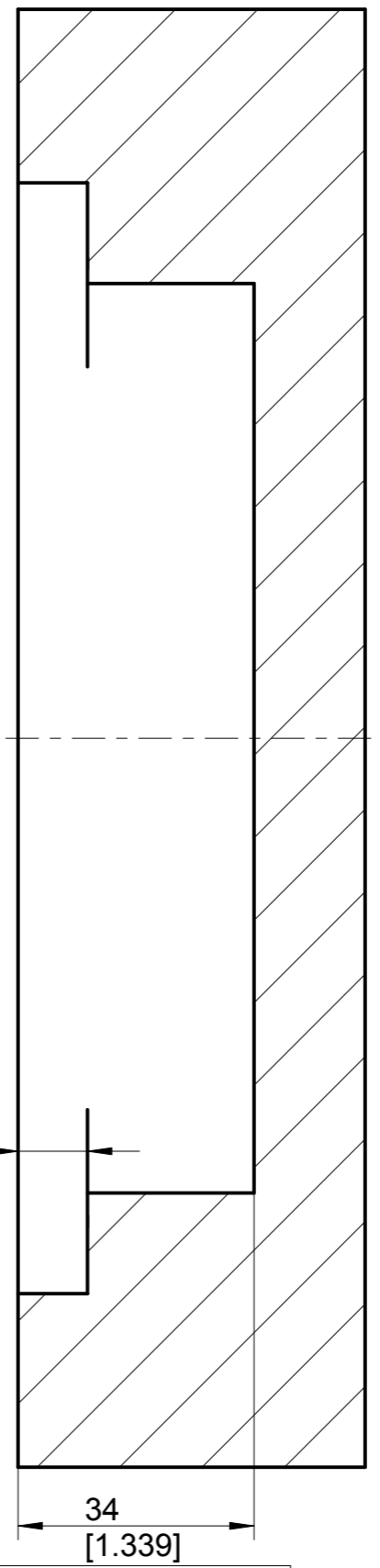

cutter 3/4"

Kunde:USA				Zul. Abweichung nach DIN:		Werkstoff:		Maßstab:	
- x -	-	-	-	-		-		1:1	
- x -	-	-	-	-		-		-	
- x -	-	-	-	Gew.		Benennung, Type:		-	
- x -	-	-	-	Datum		Name		Fräsbild Stahlzarge	
- x -	-	-	-	Gez. 26.05.20		Kirsch.		TECTUS TE340-3D SZ US	
- x -	-	-	-	Gepr. 17.06.20		Gor.		Dokumenttype: Bohr-/Fräsbild	
- x -	-	-	-	Lebenszyklusphase:		-		Verkaufs.-Nr.:	
- x -	-	-	-	Serie		-		Proje. M.	
- x -	-	-	-	Ersatz für/durch:		-		Format:	
- x -	-	-	-	-		-		A3	
- x -	-	-	-	-		-		Blatt:	
x	-	-	-	-		-		6	
Zust.	Änderung	Datum	Name	SIMONSWERK BANDTECHNIK		Zeichnungs.-Nr.:		5 400605 0 00000	